

KOOI® REACHCONTROL

Meijer Handling Solutions will shortly be introducing its KOOI® ReachControl; a patented system that includes a small flowmeter (10x8x6 cm) and an app to operate the system. As the name suggests, this flowmeter can detect the amount of oil flowing through telescopic forks. The specially developed app, compatible with standard Android or iOS devices, can be used to receive and display data of the flowdivider. The more extensive version of the KOOI® ReachControl features the ability to stop the outer sleeves at certain customer adjustable lengths (at least 8 pre-sets).



Improve safety and reduce pallet damages

Features:

- No modifications on existing and new telescopic forks
- Ideally for after sales purposes
- Useable on all brands of hydraulic telescopic forks
- Programmable by mobile app (Android / iOS)
- Free choice in numbers of pre-sets and naming
- Automatically connection with Bluetooth® signal
- More systems can be used in same area.
- No wiring needed (without auto-stop).
- Including standard tilt indicators

Optional:

- Auto-stop valve
 - Power supply 12-24 Volts
- 5" colour monitor
 - External power supply (12-24 Volts)
 - Sturdy casing and modern design
 - Can be operated with most commonly work gloves
- Forklift tablet, phone or display mount



KOOI® REACHCONTROL

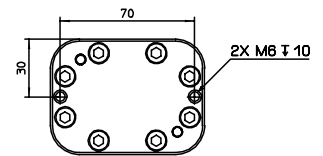
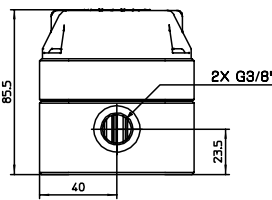
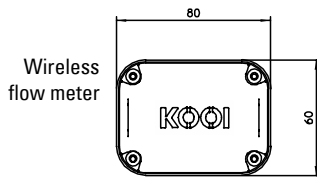
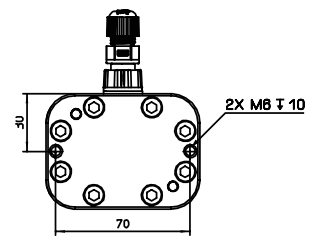
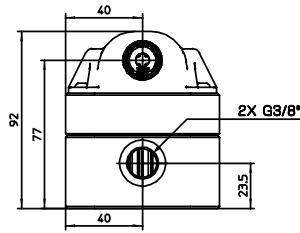
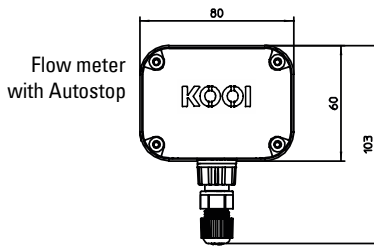

Hydraulic data

Operating pressure:	max. 250 bar / max. 3626 psi	
Nominal flow:	max. 20 L/min / max. 6.6 gal/min	
Filtration:	Class 21/19/16 according to ISO 4406 or cleaner	
Weight:	0.98 kg / 2.2 lb	
Media operating temperature range:	min 0 °C to max. +100 °C	
Ambient operating temperature range:	min. 0 °C to max. +60 °C	
Medium:	Hydraulic oil (ISO HH, ISO HL, ISO HM or ISO HV)	

Electrical data

Power supply:	without Autostop	Battery, size A, 3.6V (3.60 Ah)
	with Autostop	Wired 12 or 24 VDC
Current drawn at 20 °C (Autostop):	2 A at 12 VDC 1.3 A at 24 VDC	
Data connection:	Low power Bluetooth®	

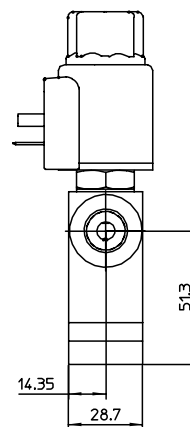
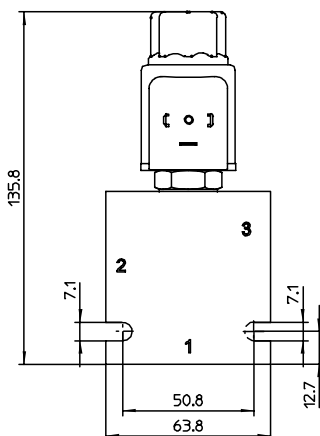
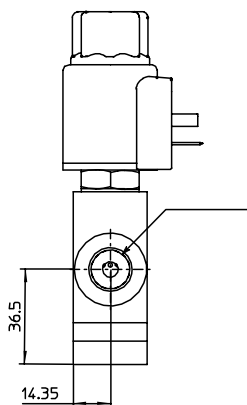

Autostop valve (optional)

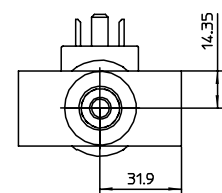

KOOI® REACHCONTROL

Controller

Electrical data		
Power supply:	without Autostop	Wired 12 or 24 VDC
Current drawn at 20 °C:		2A
Data connection		Bluetooth®
		Wi-Fi (disabled by default)

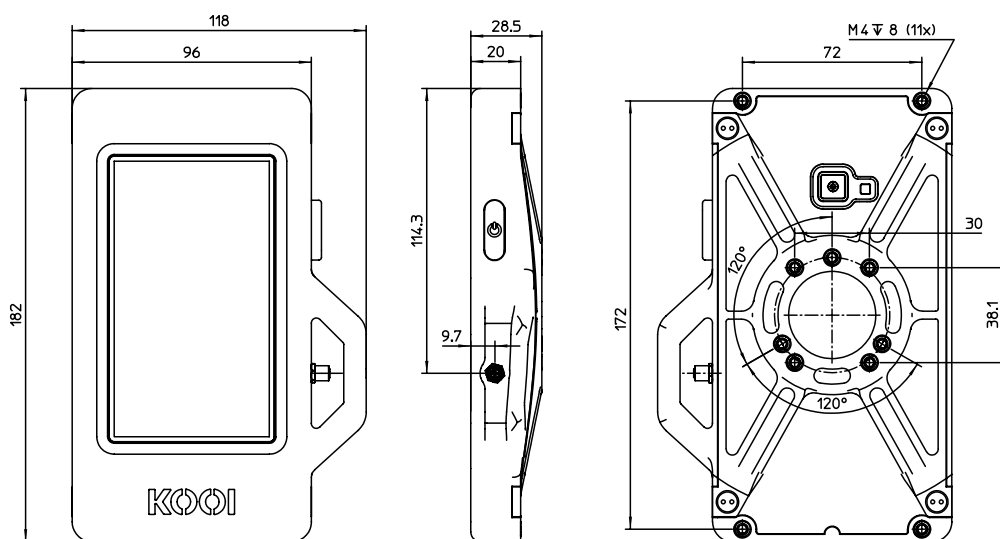

Center hole pattern is compatible with AMPS 4 and RAM® Mounts 3-hole 120° (small) hole patterns.

Bracket
KO-RAM-M01



Bracket
KO-RAM-M02

